

VIGAS COBERTURA 4/5

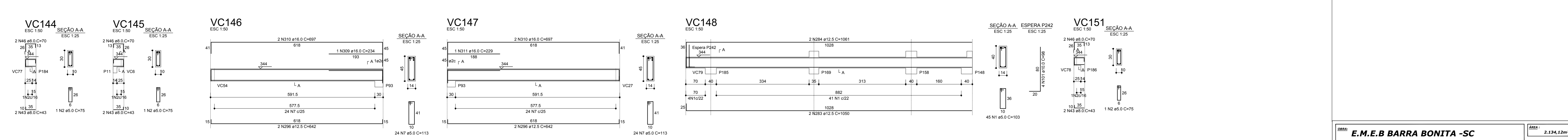
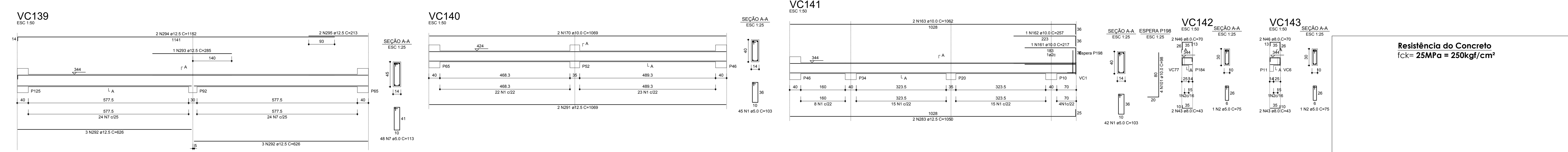
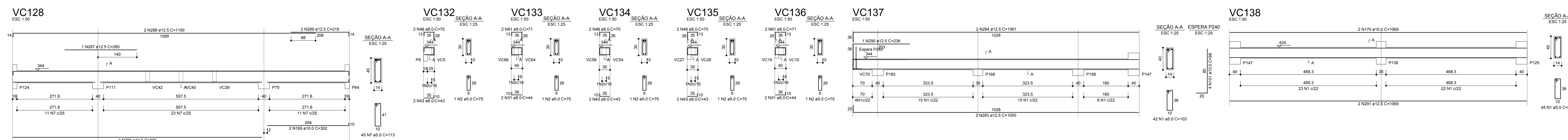
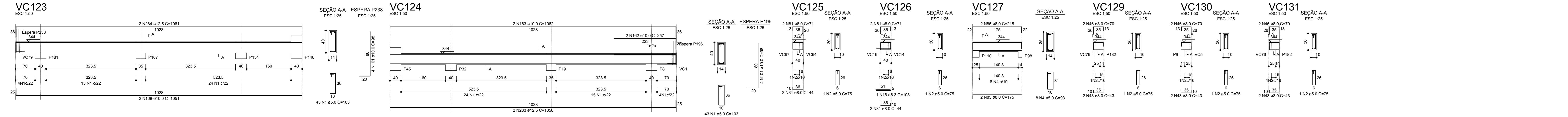
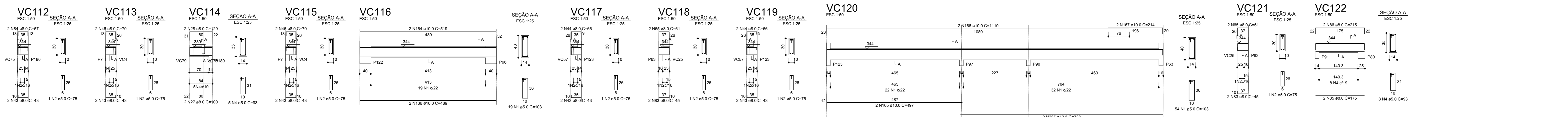
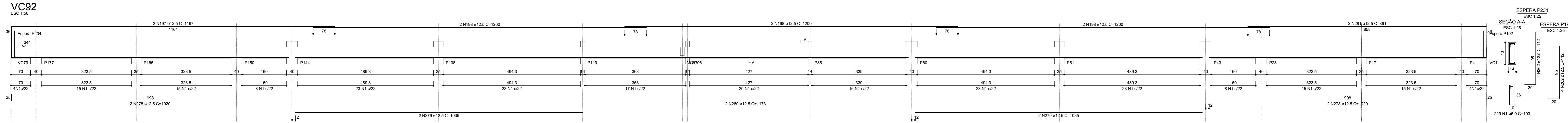
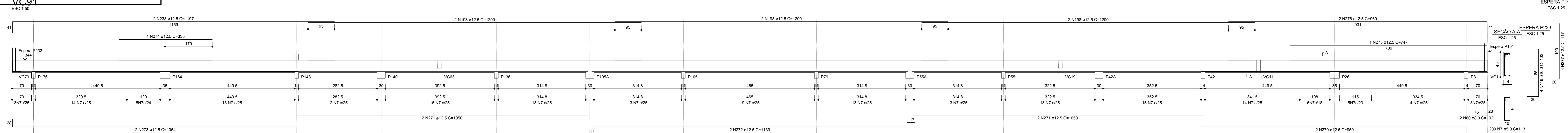

Resistência do Concreto
 $f_{ck} = 25\text{MPa} = 250\text{kgf/cm}^2$

OBRA: E.M.E.B BARRA BONITA -SC BARRA BONITA SC/SC		ÁREA: 2.134,12m ²
PROJETO: ESTRUTURAL	REFERENCIAL: - VIGAS COBERTURA 4/5	ESCALA: 1/25
PROPRIETÁRIO: MUNICÍPIO DE BARRA BONITA CNPJ: 01.612.527/0001-30	RESPONSÁVEL TÉCNICO: CLETON LUIZ BANFI ARQUITETO E URBANISTA CAU Nº: A108026-1	DATA: MAIO DE 2022
PROJ./2022/BARRA		PLANÍCIA: E18