

VIGAS BALDRAME 3/4

VB75

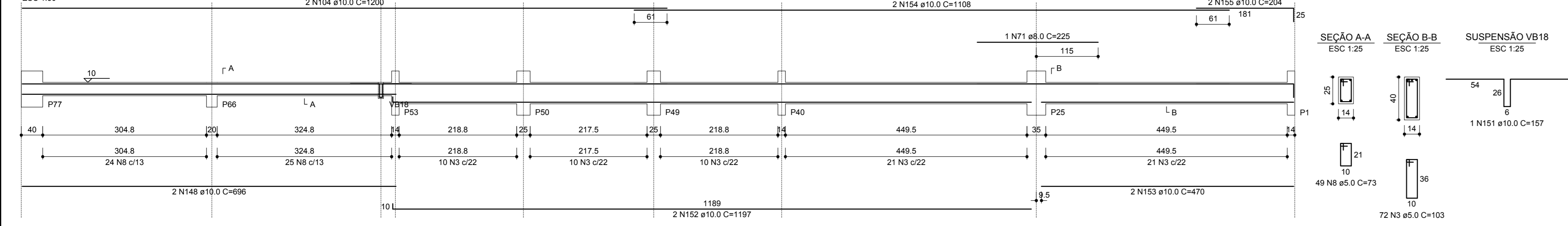

VB81

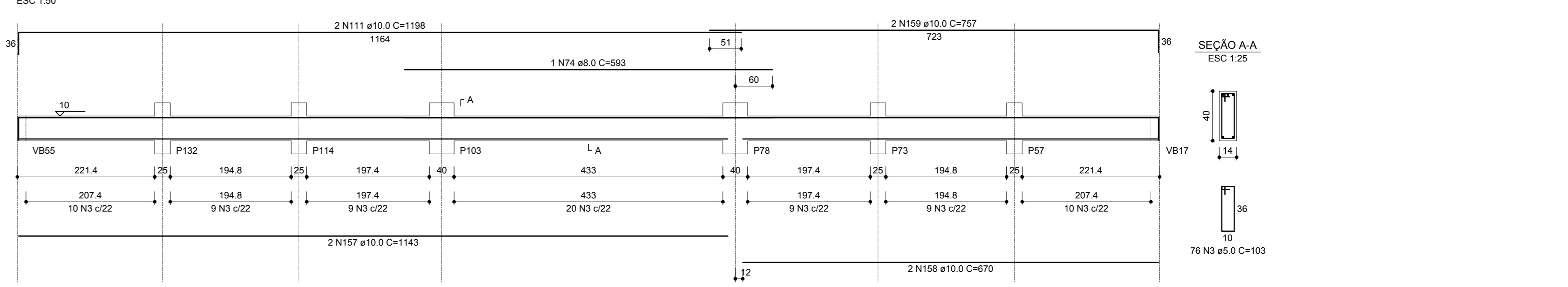

VB82

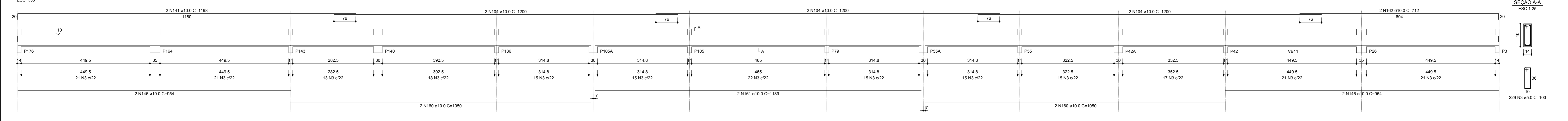

VB83

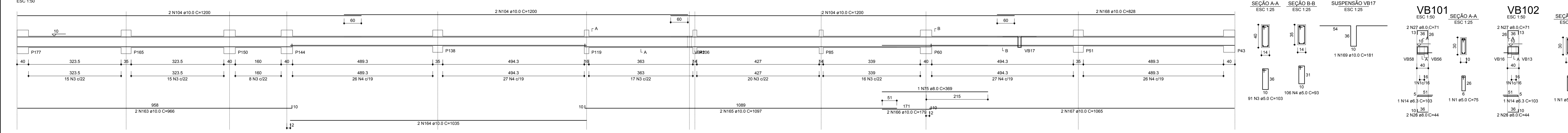

VB91

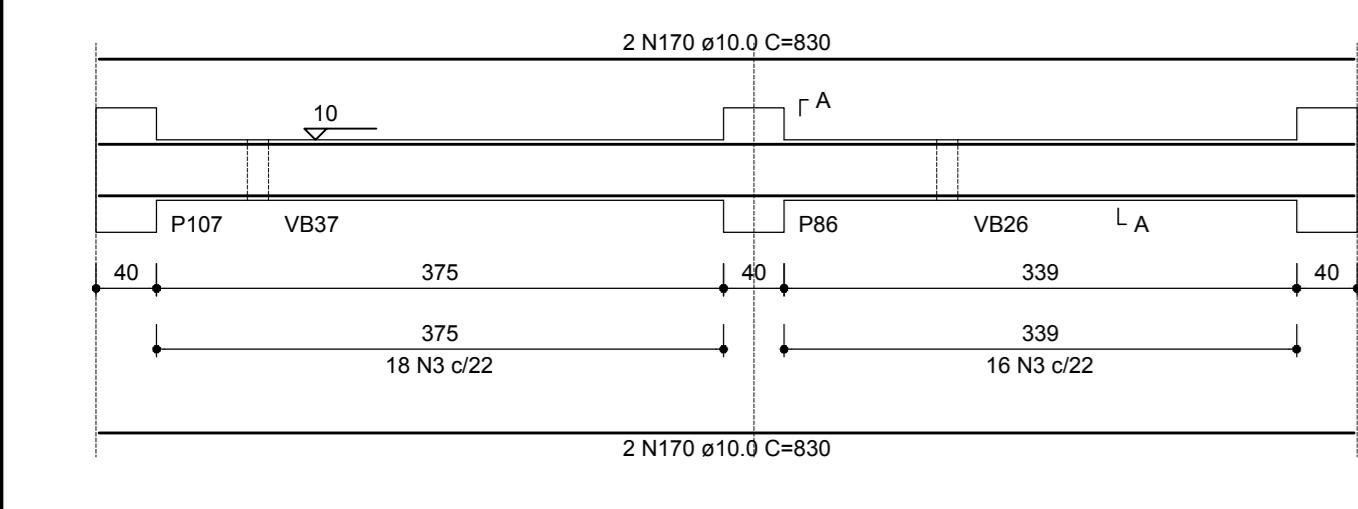

VB92

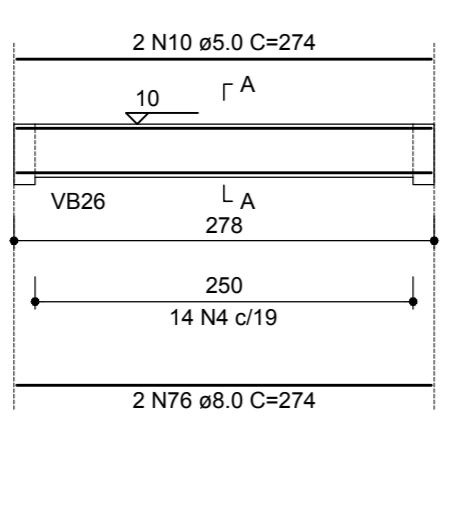

VB96

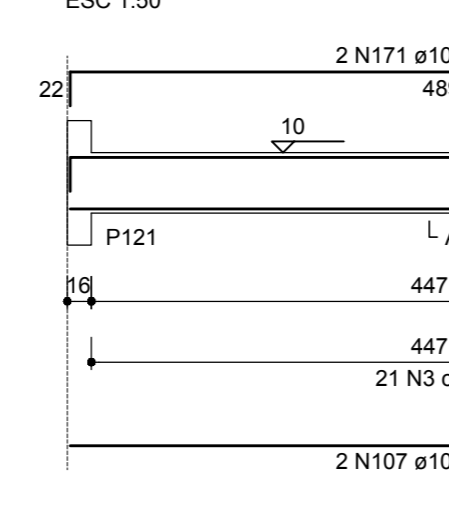

VB97

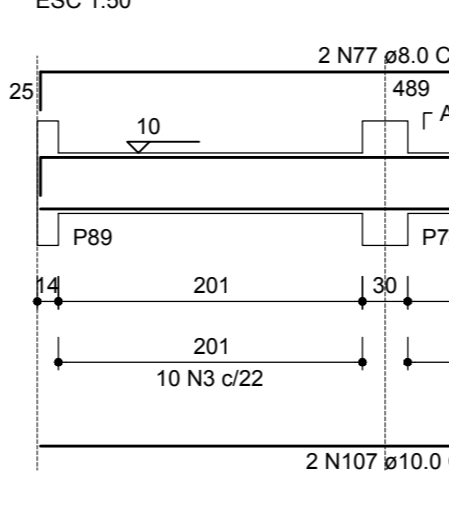

VB98

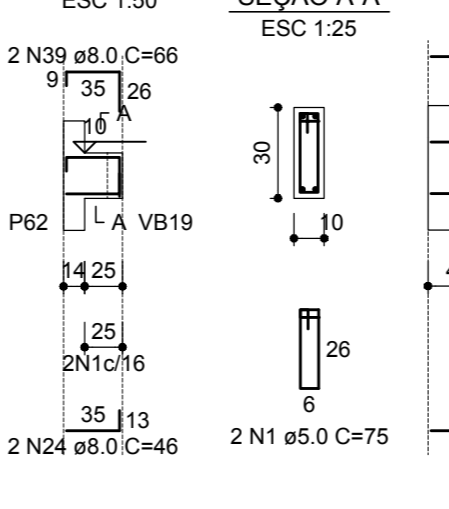

VB99

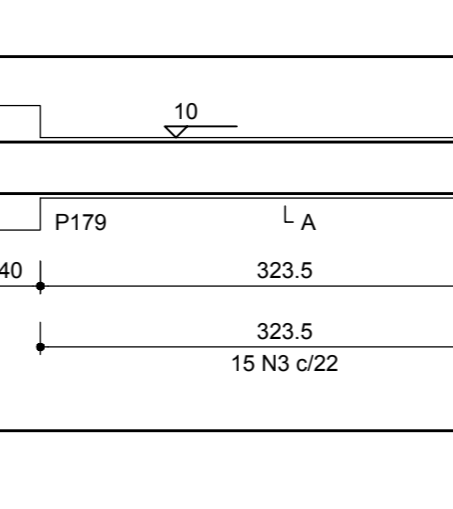

VB100

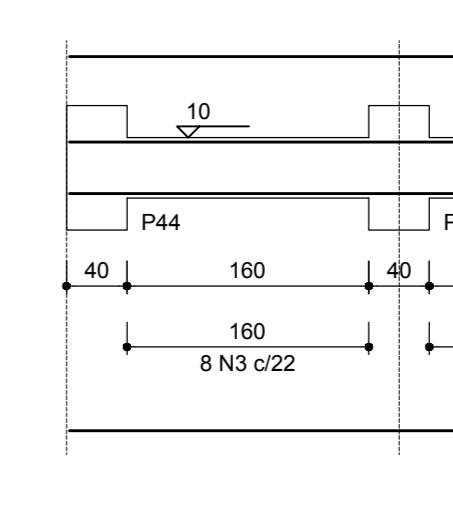

VB103

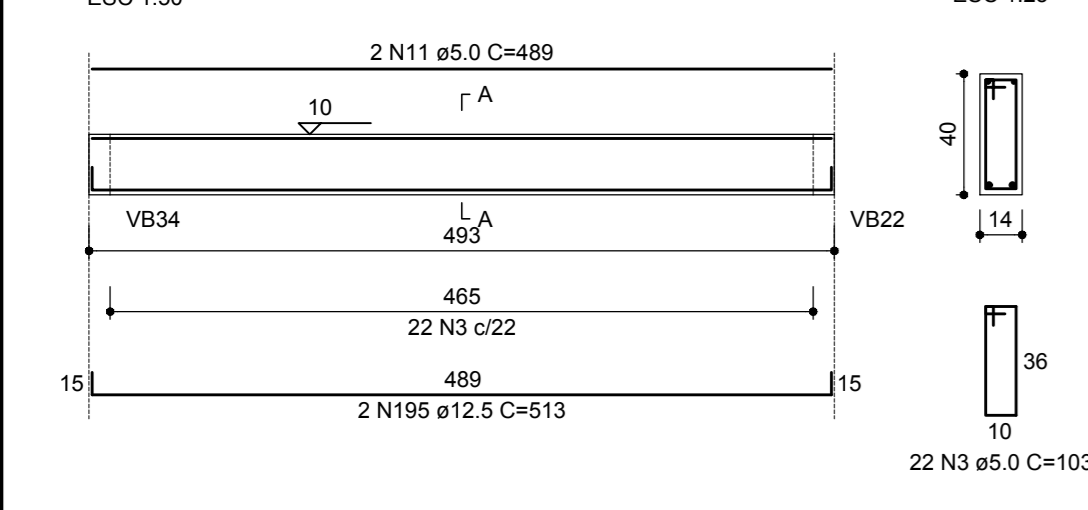

VB104

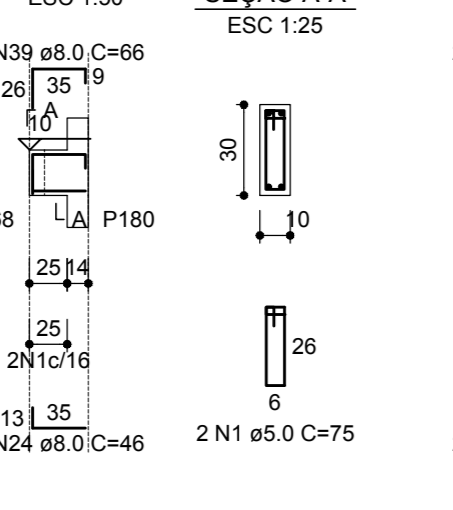

VB105

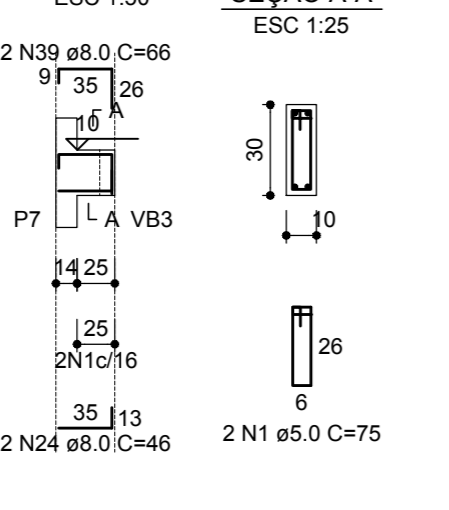

VB108

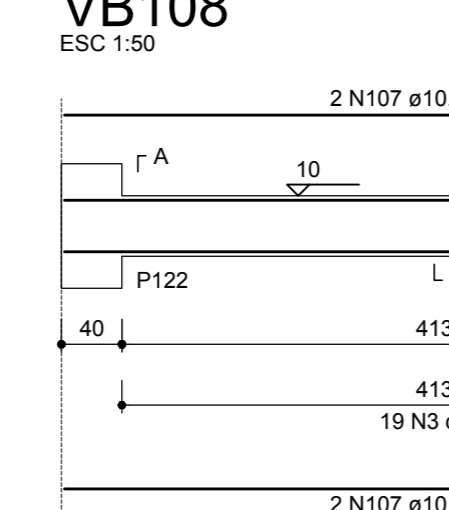

VB109

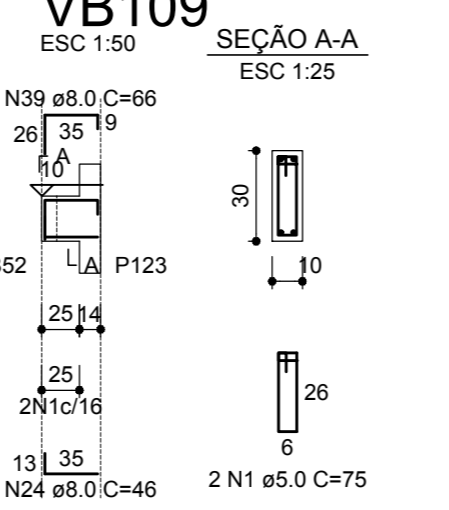

VB110

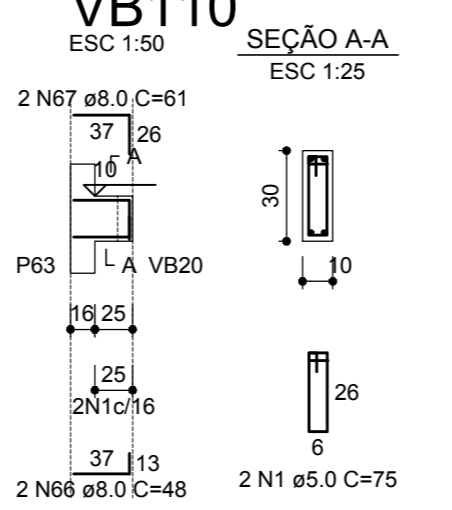

VB111

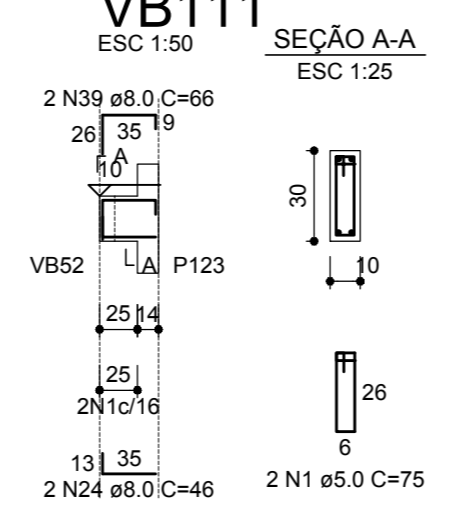

VB112

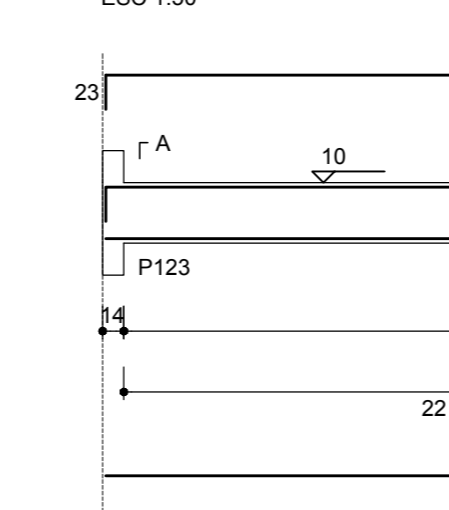

VB113

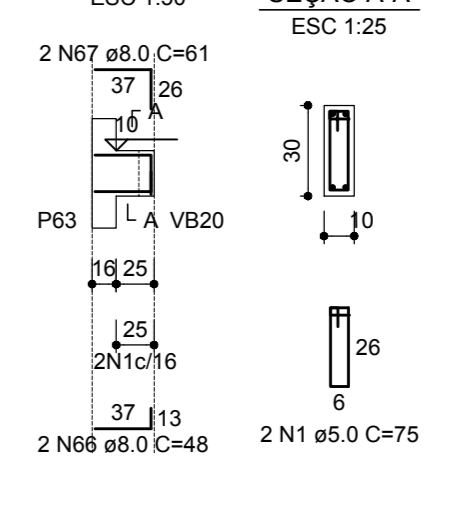

VB114

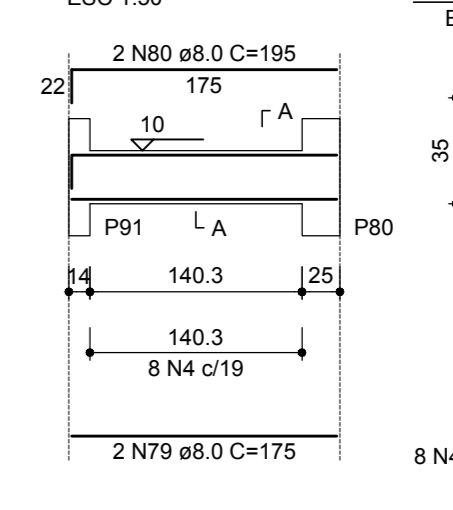

VB115

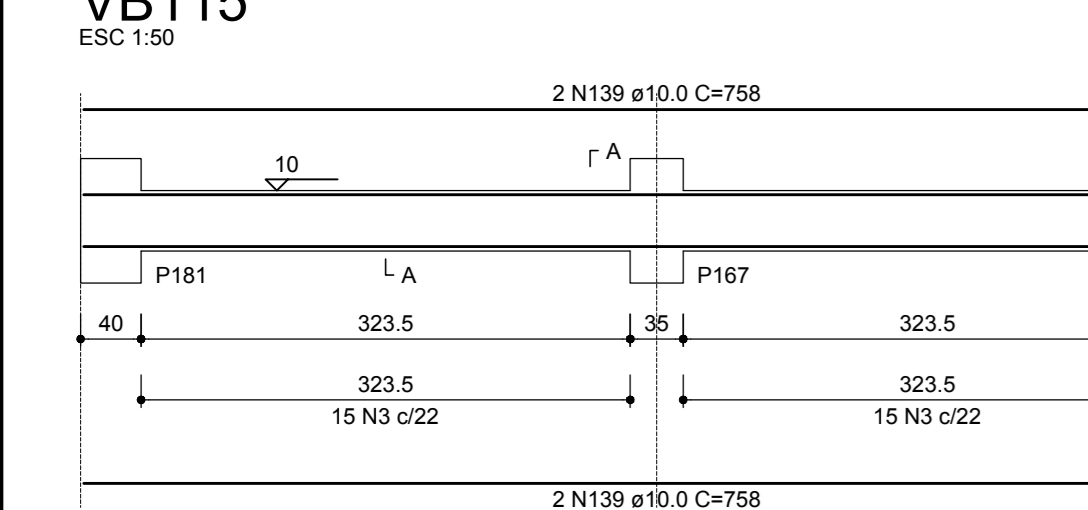

VB116

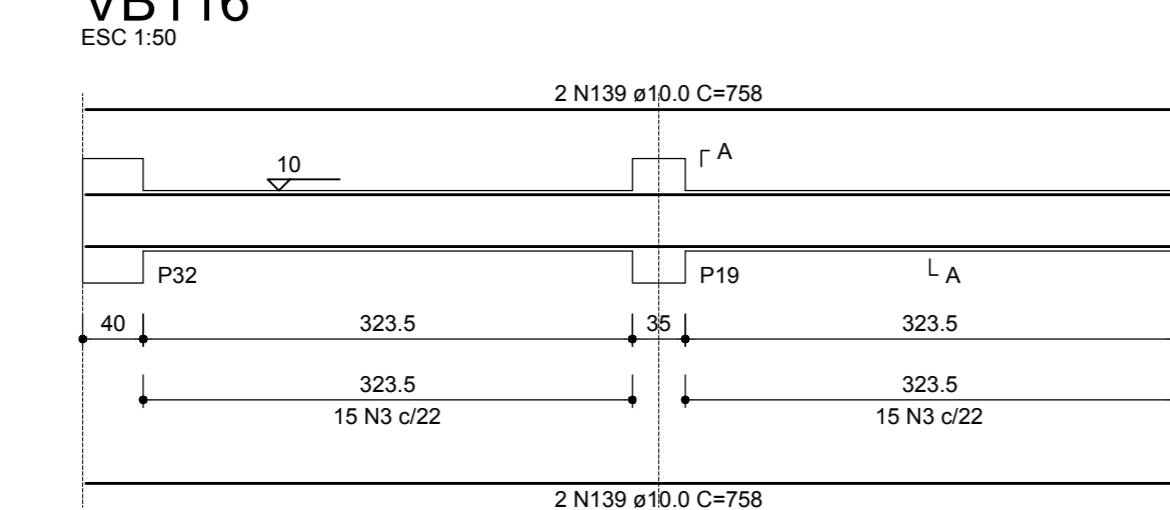

VB117

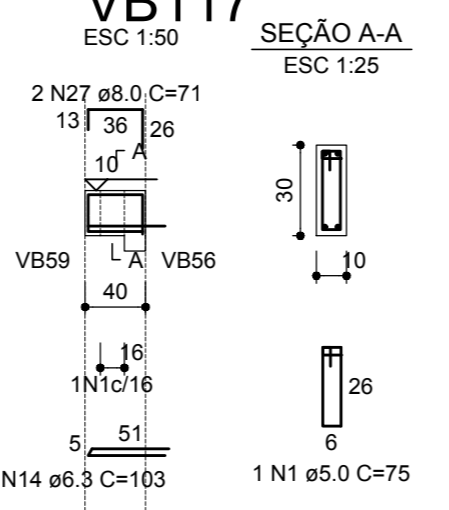

VB118

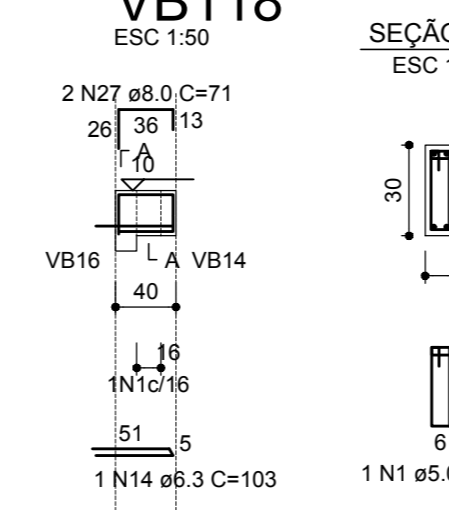

VB119

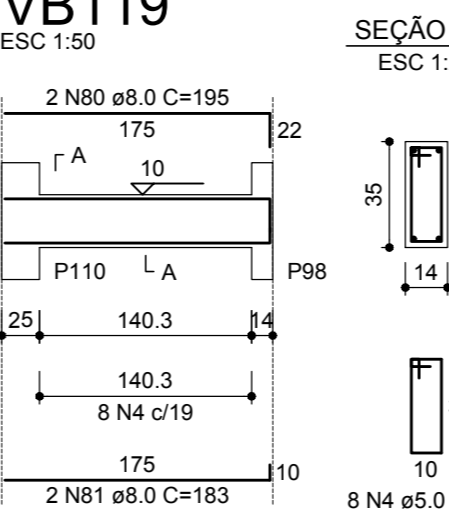

VB120

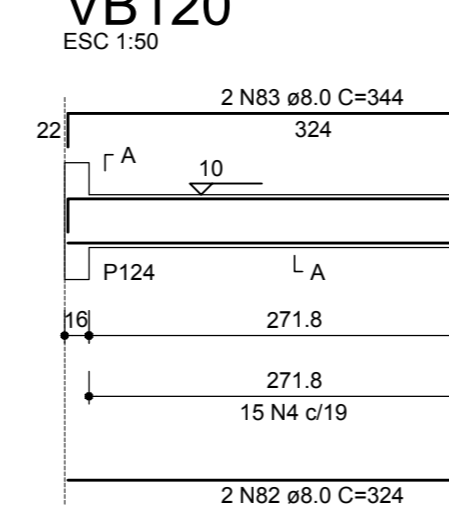

VB121

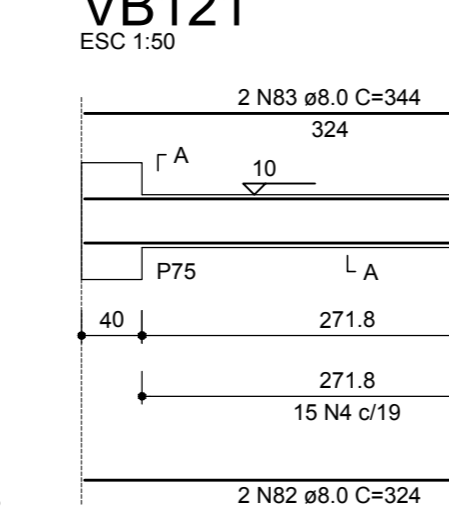

VB122

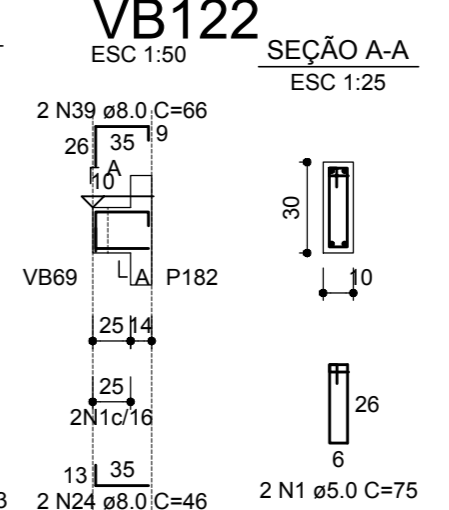

VB123

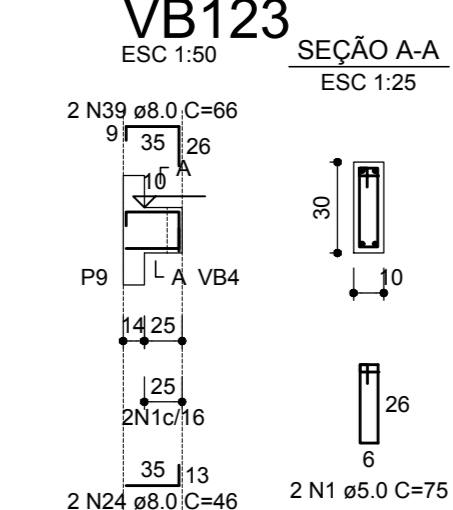

VB124

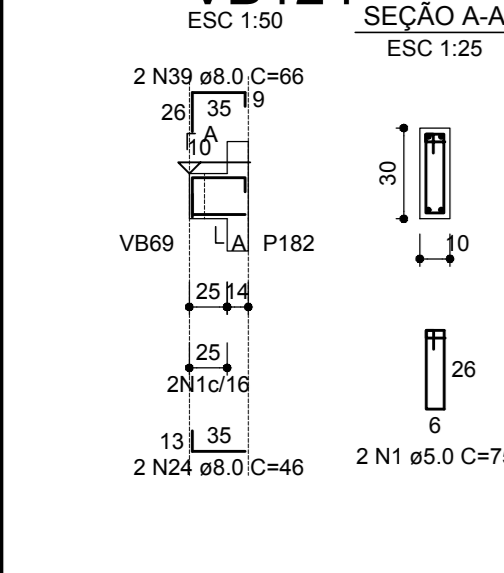

VB125

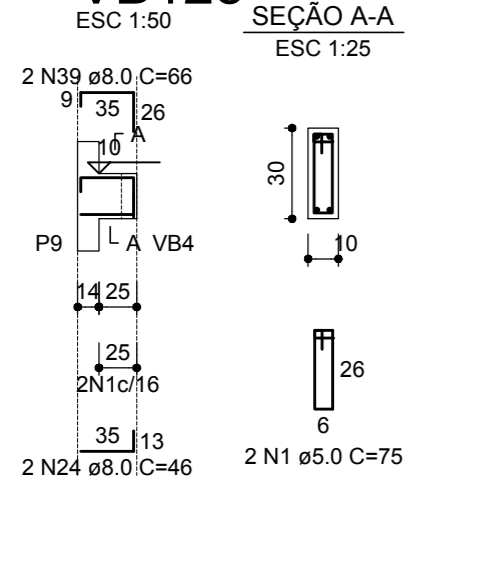

VB126

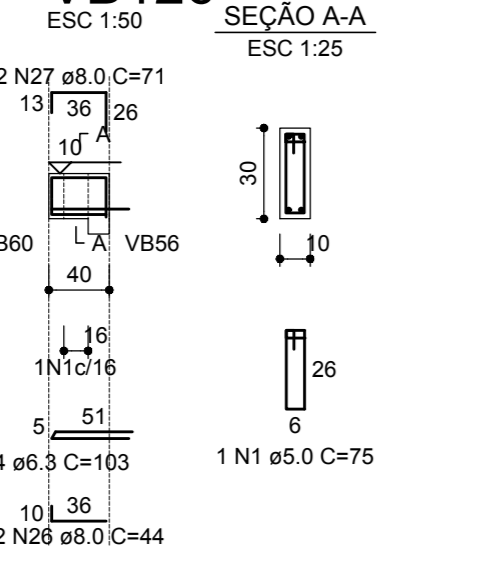

VB127

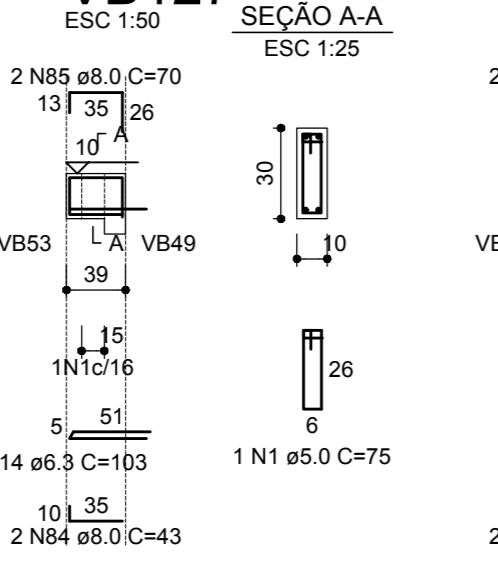

VB128

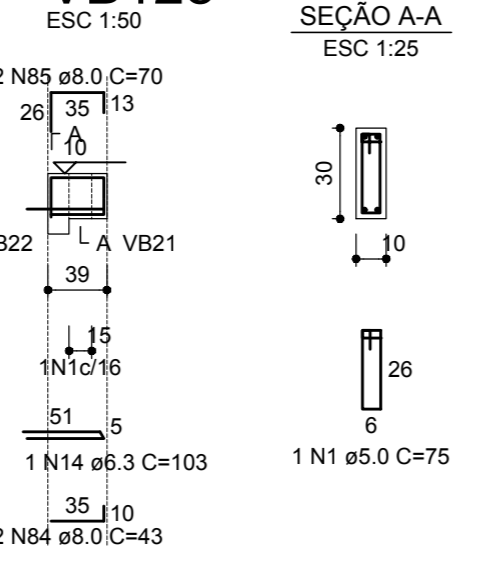

VB129

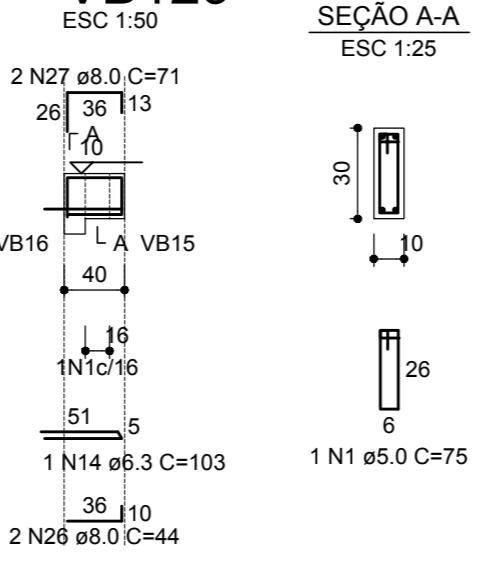

VB130

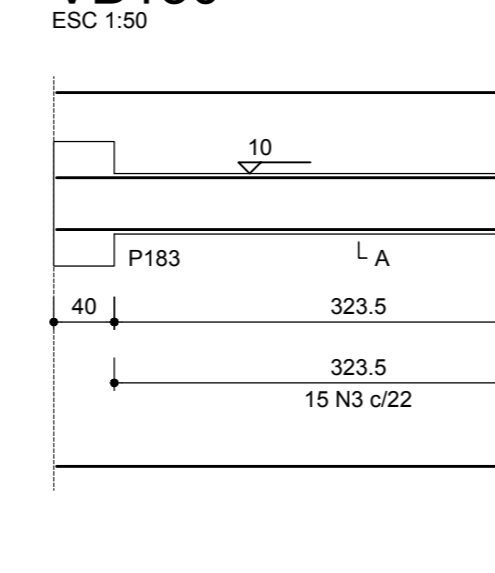

VB131

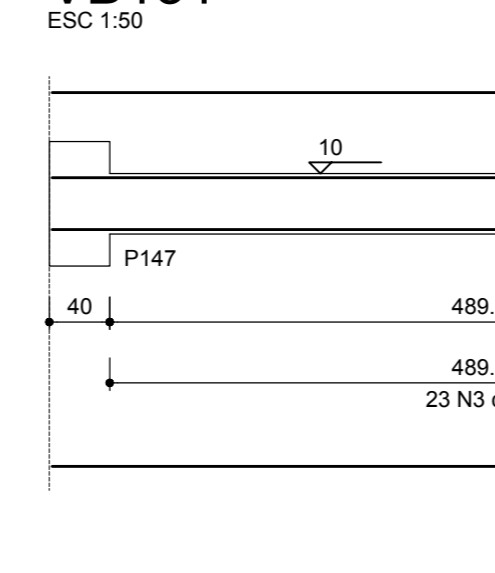

VB135

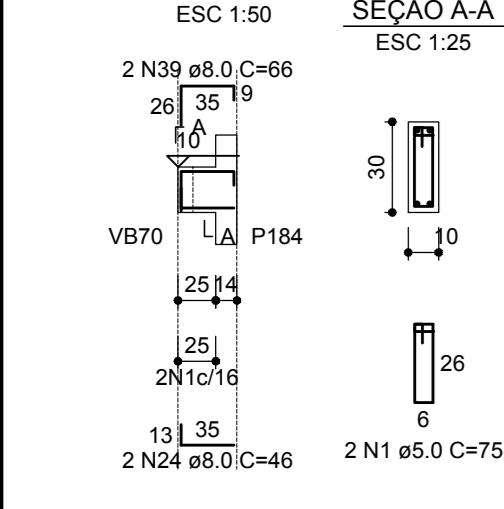

VB136

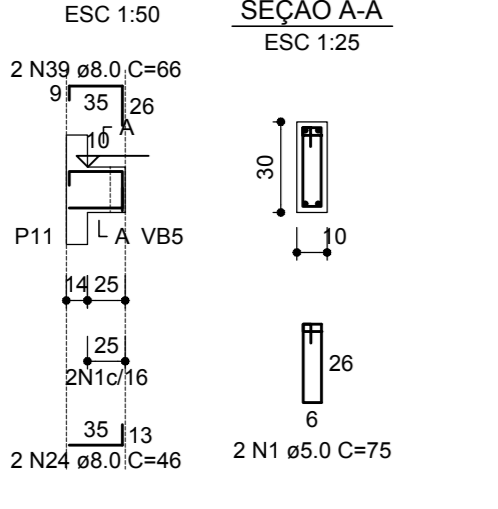

VB132

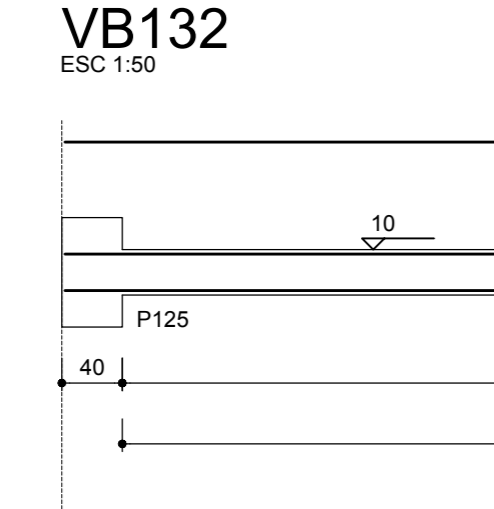

VB133

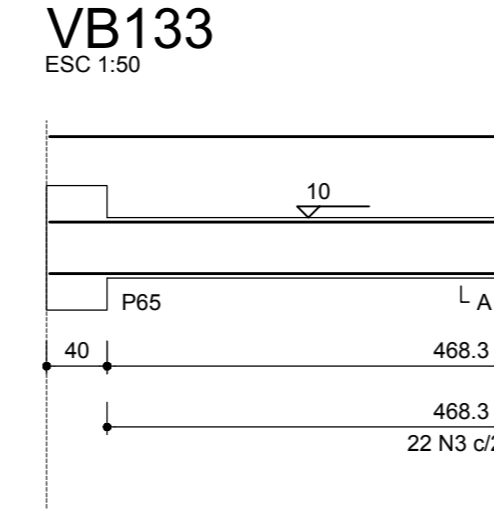

Resistência do Concreto
f_{ck} = 25MPa = 250kgf/cm²

OBRA: E.M.E.B BARRA BONITA -SC BARRA BONITA SC/SC		ÁREA: 2.134,12m ²
PRONTO: ESTRUTURAL		ESCALA: 1/75
PROPRIETÁRIO: MUNICÍPIO DE BARRA BONITA CNPJ: 01.612.527/0001-30		DATA: MAIO DE 2022
REFERENCIAL: VIGAS BALDRAME 3/4		PROJETO: CLEITON LUIZ BANFI
RESPONSÁVEL TÉCNICO: URBANE ARQUITETA INGENHEIRA TOPOLANIA FERREIRA BORGES (49) 3643-0479		REVISÃO: E13